

R-WX670KA

670Ltr* Black Glass and White Glass finish INVERTER Refrigerator

MADE IN JAPAN SERIES

Features

- 670Ltr* Capacity
- Multi Drawer French Door INVERTER refrigerator
- Only 420kWh per year power consumption
- Warranty: 5 Year Parts & Labour Warranty (Additional 5 Years Parts Warranty on the Inverter Compressor)
- Vacuum Compartment with Platinum Catalyst
- Auto Open Drawers (Lower Freezer Compartment and Vegetable Compartment)
- On Glass Controls
- Energy Saving Mode
- Delicious Freezing - Quick Freeze Drawer
- Aero-Care Vege Compartment with Platinum Catalyst
- Hitachi Original Flexible Vacuum Insulation Panel for large capacity and energy saving performance
- Sensor Cooling & Spot Powerful Cooling
- Multiple storage compartments for Fresh and Frozen Foods
- Auto Ice Maker
- Black or White Scratch-Resistant Tempered Glass
- Triple Power Deodorisation



R-WX670KAXK in Black Glass (also available in White Glass).

Dimensions: 1,833(h) x 825(w) x 728 (d) mm

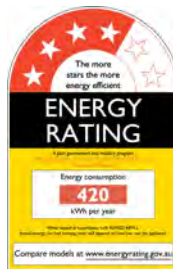

*This fridge are certified to AS/NZ IEC 62552-3.

Vacuum Compartment with Platinum Catalyst



Hitachi's uniquely designed Vacuum Compartment uses a vacuum pump to extract air and reduce oxygen to suppress oxidation, thus ensuring freshness of food while retaining its nutrients. Furthermore, the airtight structure of the compartment confines moisture inside, helping to prevent food dehydration. Seasoning is absorbed at a faster rate to assist in speedier food preparation.

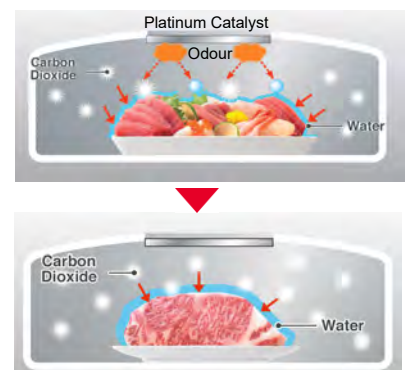

Platinum Catalyst

Odour components from meat and fish are broken down by the Platinum Catalyst to generate carbon dioxide. The carbon dioxide dissolves in water on the surface of food items to make the surface weakly acidic, suppressing enzyme strength to minimize freshness loss.



ÜËÿ ÝÍİ €SXSÁ



R-WX670KAXW

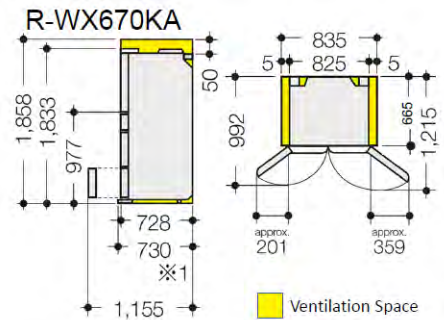
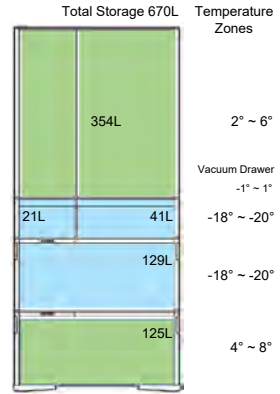

On Glass Controls



Touch the MENU button and the control panel display appears on the door, so you can control settings without having to open the door.

Easy-to-Open Auto Drawers



Easy-to-Open Auto Drawer (Vegetable & Freezer Drawers). The drawer slides out effortlessly even if it's full of items and heavy.

Delicious Freezing Quick Freeze Drawer



Delicious Freezing process reduces the time food takes to be frozen. Ice crystal formation is reduced and moisture retained.

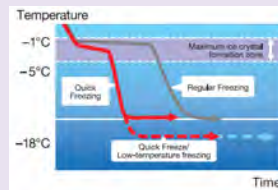

Vacuum Insulation Panel

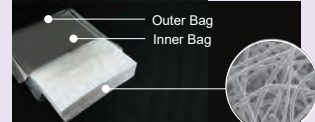

Vacuum Insulation for maximised Efficiency

Easy Access Storage Drawers



Platinum Catalyst's Freshness Preservation

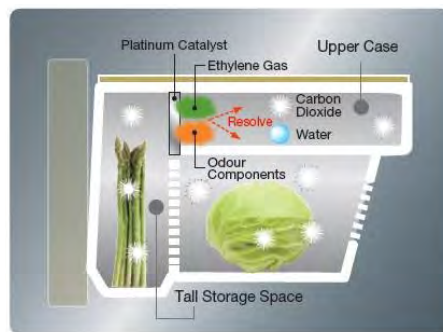

Ethylene gas released by vegetables can spoil their freshness. Platinum catalyst technology has the ability to decompose the ethylene gas and convert it into carbon dioxide gas, delaying spoilage by making vegetables dormant to preserve freshness.

Sensor Cooling & Spot Powerful Cooling



With Sensor Cooling the lower 2 shelves can be set at approx. 2°C, which is lower than the regular refrigerator temperature. The sensor detects temperature changes and adjusts the cooling power to maintain the 2°C temperature in the right lower compartment.

Use Spot Powerful Cooling for quick cooling One-Touch Operation to save you time.